

DATA SHEET





OXY-LC

Oxygen Sensor Interface Board

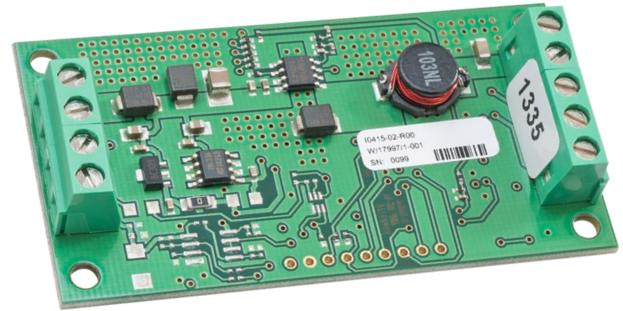
FEATURES

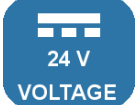
- Provides the electronics necessary to power and control SST's range of zirconium dioxide (ZrO₂) sensors
- Built in pressure sensor for barometric pressure compensation
- Interface mounted screw terminals for easy wiring with reverse voltage and transient overvoltage

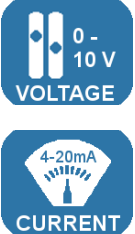

<p>Supply Voltage</p>  <p>24 V VOLTAGE</p>	<p>Temp</p>  <p>-30°C to +70°C TEMPERATURE</p>	<p>Digital Output</p>  <p>RS485 PWM</p>	<p>Analogue Output</p>  <p>0 - 10 V VOLTAGE 4-20mA CURRENT</p>	<p>Response Time</p>  <p>< 4 secs < 15 secs</p>
---	---	--	---	--

BENEFITS

- Adaptive software filtering provides a fast sensor response coupled with a stable oxygen output
- High accuracy linear output

OUTPUT VALUES

Oxygen range (analogue output)	0.1 ² —25% O ₂ or 0.1 ² —100% O ₂
Oxygen range (Modbus RTU)	0.1 ² —100% O ₂
Accuracy after calibration ³	0.5% O ₂
Repeatability after calibration	0.5% O ₂
Output resolution	0.01% O ₂
Response time (step 10—90%)	
Fast response sensor connected:	4s
Standard response sensor connected:	15s
Initial warm up time (till stable output)	5—10mins
Output inactive start up delay (heater warm up)	
From OFF to ON mode:	60s
From Standby to ON mode (RS485 only):	20s

TECHNICAL SPECIFICATIONS

Supply voltage	
RS485 variant:	8—28V _{DC}
Analogue variants:	20—28V _{DC}
Supply current	600mA max. at 24V _{DC} 1.2A max. at 12V _{DC}
Digital output	RS485 (Modbus RTU) or PWM
Analogue output	4—20mA; load 600Ω max or 0—10V _{DC} ; load 10kΩ min
Temperature limits	
Storage:	-40°C to +85°C
Operating:	-30°C to +70°C
Operating pressure limits ¹	260—1260mbar absolute

Need help? Ask the expert
Tel: + 44 (0)1236 459 020
and ask for "Technical"



1) Sensor and interface for correct barometric pressure compensation.
 2) Prolonged operation below 0.1% O₂ can damage the sensing element.
 3) Analogue output variants accuracy stated is valid when calibrated at the default calibration value. RS485 variant accuracy stated is valid when calibrated at the default 20.7% O₂ over the range 0.1 to 25% O₂. For maximum accuracy above 25% O₂ the interface and sensor should be calibrated to full scale of the required range using certified gas.



Always handle the interface board using the correct ESD handling precautions.

RS485 Variant

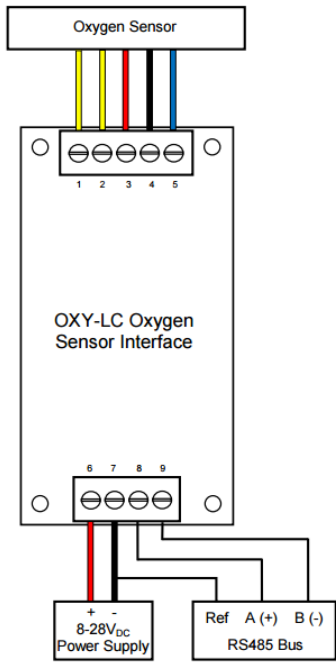

Analogue Variants

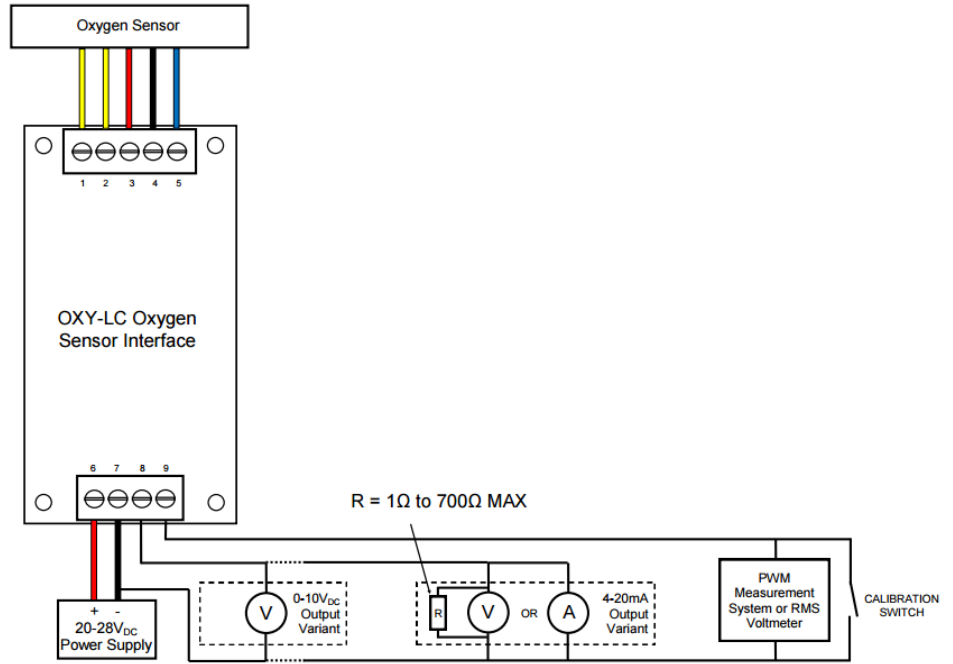

Pin	Assignment
1	Sensor Heater + (1)
2	Sensor Heater 0V _{DC} (2)
3	Sensor Pump
4	Sensor Common
5	Sensor Sense
6	8—28V _{DC}
7	0V _{DC}
8	RS485 A (+)
9	RS485 B (-)

Pin	Assignment
1	Sensor Heater + (1)
2	Sensor Heater 0V _{DC} (2)
3	Sensor Pump
4	Sensor Common
5	Sensor Sense
6	20—28V _{DC}
7	0V _{DC}
8	4—20mA or 0—10V _{DC}
9	Calibrate IN/PWM OUT

Comm. Setting	Default Value
Address	1
Baudrate	9600
Parity	None
Stopbits	1

O ₂ %	Output Value			
	0—10V _{DC}		4—20mA	
	0.1—25% O ₂	0.1—100% O ₂	0.1—25% O ₂	0.1—100% O ₂
20.7%	8.28V _{DC}	2.07V _{DC}	17.25mA	7.34mA
100%	-	10V _{DC}	-	20mA
90%	-	9.0V _{DC}	-	18.4mA
25%	10V _{DC}	2.5V _{DC}	20mA	8mA
5%	2.0V _{DC}	0.5V _{DC}	7.2mA	4.8mA
0.1%	0.04V _{DC}	0.01V _{DC}	4.06mA	4.02mA

Notes:

- Output pins 1 through 5, refer to appropriate SST oxygen sensor datasheet for wiring/pin designations.
- Every SST oxygen sensor has two heater connections which should be connected to pins 1 & 2 of the OXY-LC; the heater coil has no polarity. However when connecting to a sensor where the sensor housing is one of the heater connections, pin 2 of the OXY-LC should be connected to the housing.



ORDER INFORMATION

Generate your specific part number using the convention shown below. Use only those letters and numbers that correspond to the options you require — omit those you do not.

Digital Variant

O X Y - L C - 4 8 5

Analogue Variants

O X Y - L C -

X	X	X
---	---	---

 -

X	X	X
---	---	---

Output Type	O ₂ Measurement Range (vol O ₂ %)	Heater Voltage / Response Time / Termination
A Current: 4—20mA	25 Analogue 0.1—25%	400 4.00V, 15s response sensor, short cable (<150mm)
V Voltage: 0—10V	100 Analogue 0.1—100%	420 4.20V, 15s response sensor, long cable (>150mm)
		435 4.35V, 4s response sensor, short cable (<150mm)
		455 4.55V, 4s response sensor, long cable (>150mm)



Rua Dr. Afonso Cordeiro, 80 Tel. +351. 229 385 139
4450-001 MATOSINHOS Fax. +351. 229 385 140

geral@dicofiltro.com

www.dicofiltro.com

! CAUTION

Do not exceed maximum ratings and ensure sensor(s) are operated in accordance with their requirements.

Carefully follow all wiring instructions. Incorrect wiring can cause permanent damage to the device.

Zirconium dioxide sensors are damaged by the presence of silicone. Vapours (organic silicone compounds) from RTV rubbers and sealants are known to poison oxygen sensors and MUST be avoided. Do NOT use chemical cleaning agents.

Failure to comply with these instructions may result in product damage.

i INFORMATION

As customer applications are outside of SST Sensing Ltd.'s control, the information provided is given without legal responsibility. Customers should test under their own conditions to ensure that the equipment is suitable for their intended application.

For detailed information on the sensor operation refer to application note AN0043 Operating Principle and Construction of Zirconium Dioxide Oxygen Sensors.

For technical assistance or advice, please email:
technical@sstsensing.com

General Note: SST Sensing Ltd. reserves the right to make changes to product specifications without notice or liability. All information is subject to SST Sensing Ltd.'s own data and considered accurate at time of going to print.